

AM · PM

JOY



W85G-205-090GT
W85T-205-090W

ENG · RUS



Installation instructions

- Installation of item should be carried out only by qualified personnel, following the instructions of this guidance.
- Assembly is carried out by two persons.
- Please, check for presence of all details after unpacking. Glass panels must be transported vertically.
- Please, lean glass panels vertically against the wall during assembly of other parts.
- It is expressly prohibited to tap upon corners of glass panels.



Product maintenance

- For the avoidance of damage of the surface of the product it is not allowed to use water of temperature more than 60 °C.
- Use only mild detergents and soap for cleaning of the item.

- Do not use corrosive washing agents or abrasive pastes for cleaning of the item.
- Accute contamination on the surface is recommended to treat with diluted vinegar and wash off with water.
- Shallow scratches (for acrylic parts of the item) can be removed with fine grid sandpaper (grade 2000).

Producer has a right to introduce change of component parts that has no effect on appearance and functionality of product. All parameters indicated in this instruction have formal meaning. Producer reserves the right for technical changes.

After assembly sealant must be given some time to harden. It is forbidden to use item within 24 hours after completion of installation.



Указания по монтажу

- Установка изделия должна производиться только квалифицированным персоналом, следуя инструкциям данного руководства.
- Сборка осуществляется силами двух человек.
- После распаковки проверьте наличие всех деталей. Стеклопакетные панели должны транспортироваться вертикально.
- После распаковки стеклопакетные панели прислоняйте вертикально к стене на время сборки остальных частей.
- Категорически запрещается стучать по углам стеклянных панелей.



Уход за продуктом

- Во избежание повреждения поверхности изделия не допускается использование воды температурой более 60 С.
- Используйте для очистки изделия мягкие моющие средства или мыло.
- Не используйте для очистки изделия агрессивные моющие средства или абразивные пасты.

- Сильные загрязнения на поверхности рекомендуется обработать разбавленным уксусом и затем смыть водой.
- Неглубокие царапины (для акриловых составляющих изделия) могут быть удалены мелкозернистой наждачной бумагой (зернистость 2000).

Производитель имеет право на изменение комплектации, не влияющее на внешний вид и функционал продукта. Все параметры, указанные в данной инструкции, имеют формальное значение. Производитель оставляет за собой право на технические изменения.

Места примыкания изделия к стенам обработайте силиконовым герметиком (показан к применению любой силиконовый герметик отвечающий свойствам pH-нейтральности, бесцветности, противогрибкости).

После сборки требуется дать время затвердевания герметика. Не рекомендуется использование изделия в течении 24 часов после завершения монтажных работ.

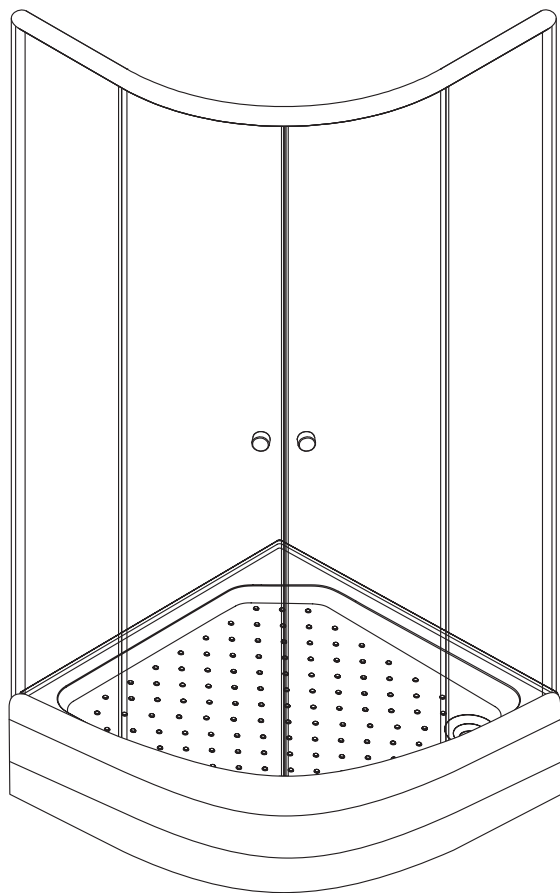

Joy
W85G-205-090GT

ENG Shower enclosure
RUS Душевое ограждение

Joy
W85T-205-090W

ENG Shower tray
RUS Душевой поддон

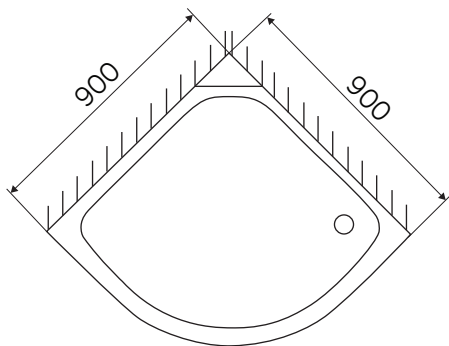
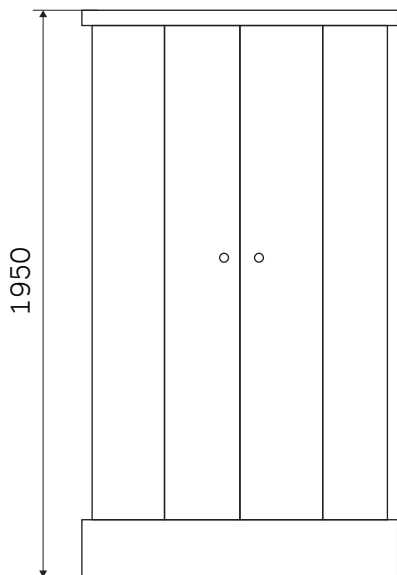

- A - вывод канализации
- B - вывод фитингов ГВС, ХВС
- 1 - вывод d 50
- 2 - пол плитка
- 3 - стена плитки

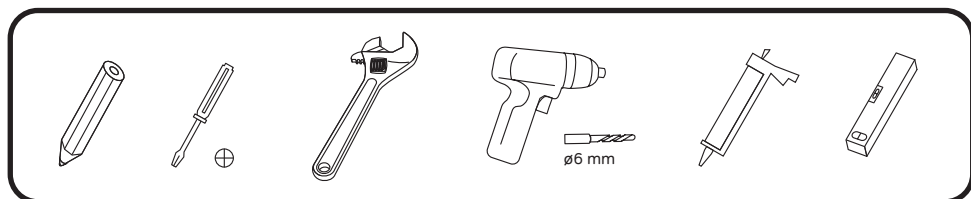
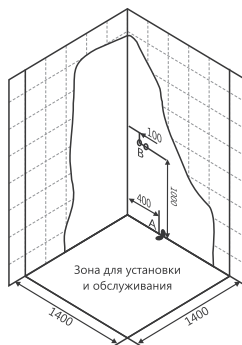
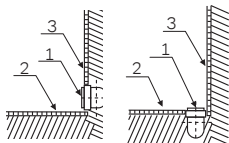

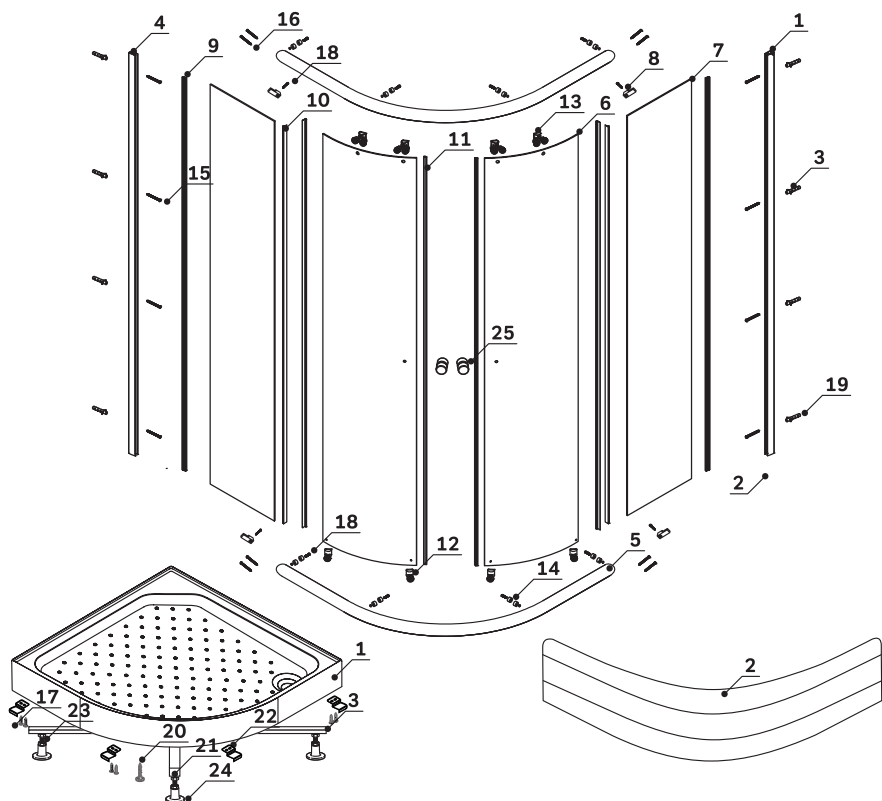

01	tray	поддон	×1
02	screen	экран	×1
03	frame	рама	×1
04	profile vertical	вертикальный алюминевый профиль	×2
05	profile horizontal	горизонтальный алюминевый профиль	×2
06	glass door	дверь стеклянная	×2
07	fixed glass	стекло неподвижное	×2
08	fixed glass holder	держатель неподвижных стекол	×4
09	glass seal	уплотнитель неподвижных стекол	×2
10	sealing of glass F-shaped	силиконовый F - образный уплотнитель	×4
11	seal magnetic	силиконовый магнитный уплотнитель	×2

12	bottom roller	ролик (нижний)	×4
13	upper roller	ролик (верхний)	×4
14	door stoper	ограничитель хода дверей	×8
15	screw 3,9x25	шуруп 3,9x25	×8
16	screw 3,5x25	шуруп 3,5x25	×8
17	screw 3,9x15	шуруп 3,9x15	×10
18	screw 3,9x9,5	шуруп 3,9x9,5	×12
19	dowel 6x30	дюбель 6x30	×8
20	screw 3,5x39	саморез 3,5x39	×10
21	nut M12	гайка M12	×12
22	bracket for shelf	кронштейн для крепления	×5
23	stud M12	шпилька M12	×6
24	leg	ножка	×6
25	handle	ручка двери	×2

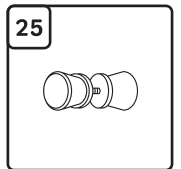
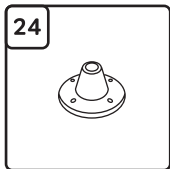
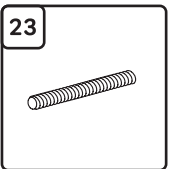
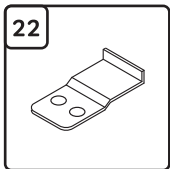
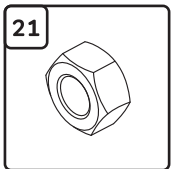
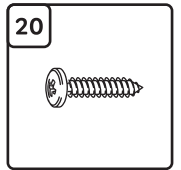
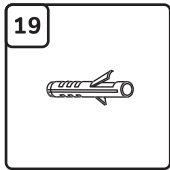
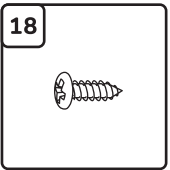
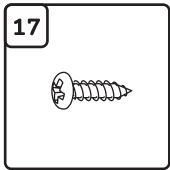
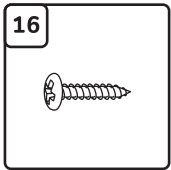
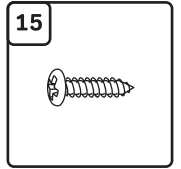
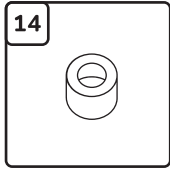
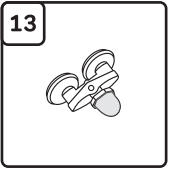
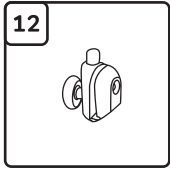
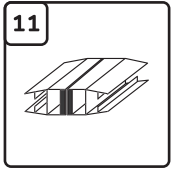
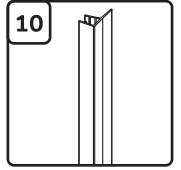
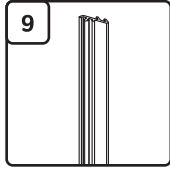
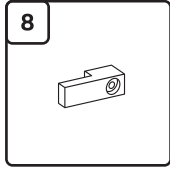
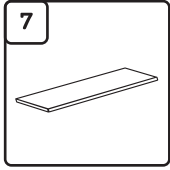
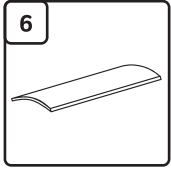
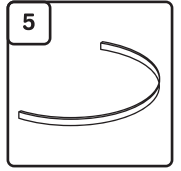
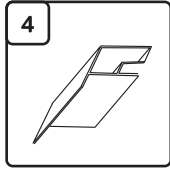
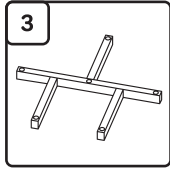
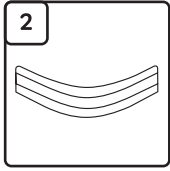
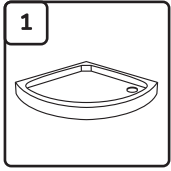

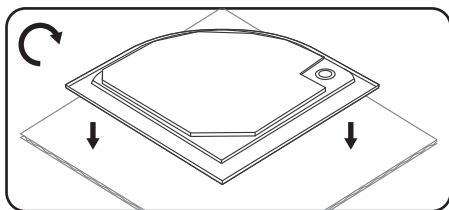
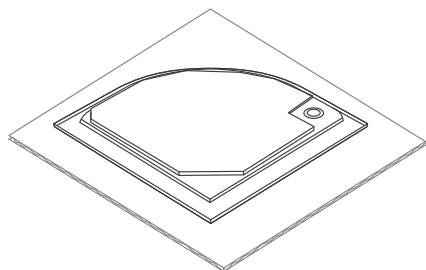

1

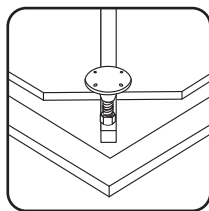
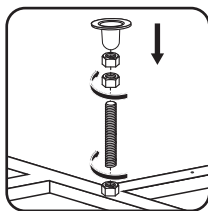
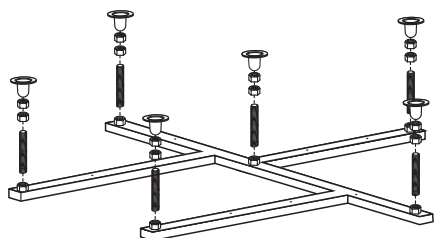

3 21 23 24

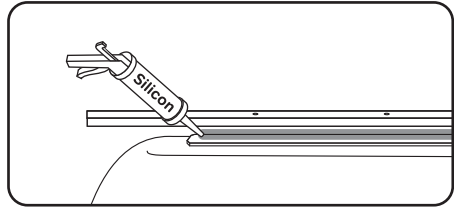
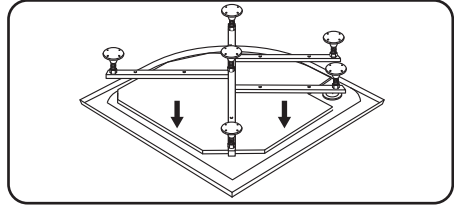
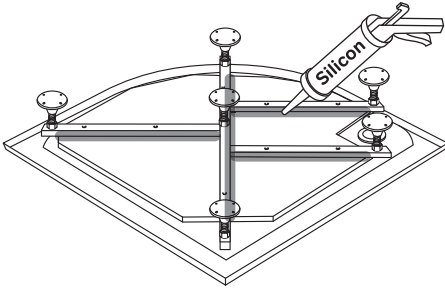

1

3

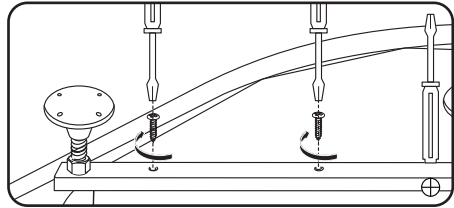
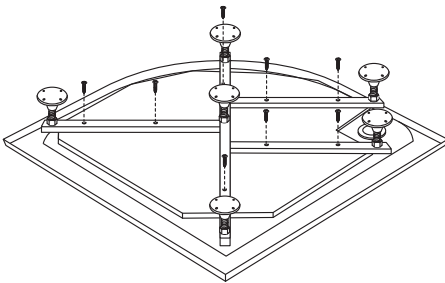

Шурупы необходимо
вкручивать строго
в доску МДФ.



20

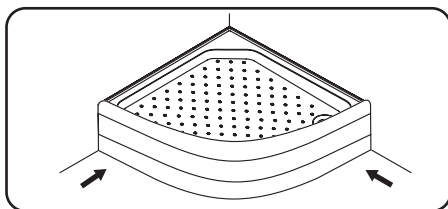
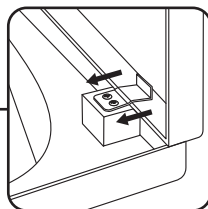
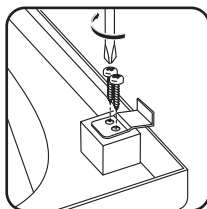
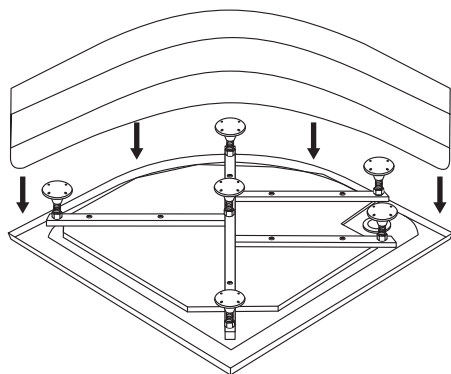
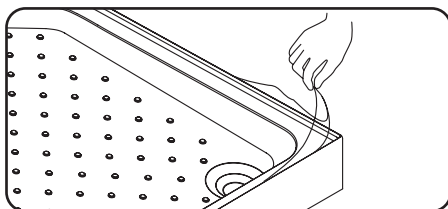
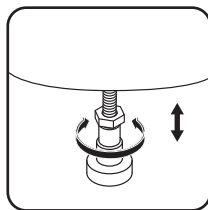
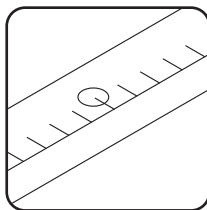
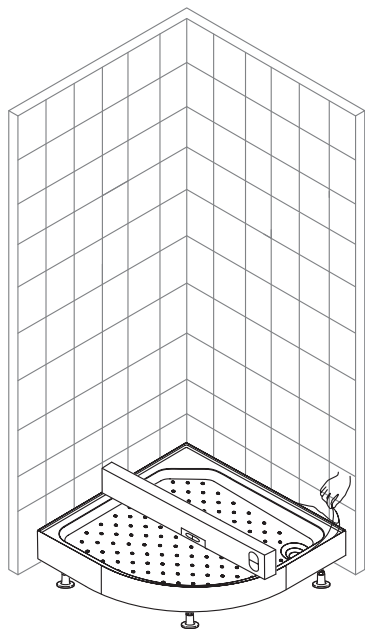

- 1
- 2
- 22
- 17

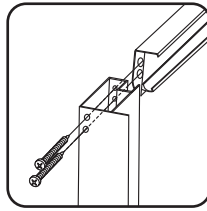
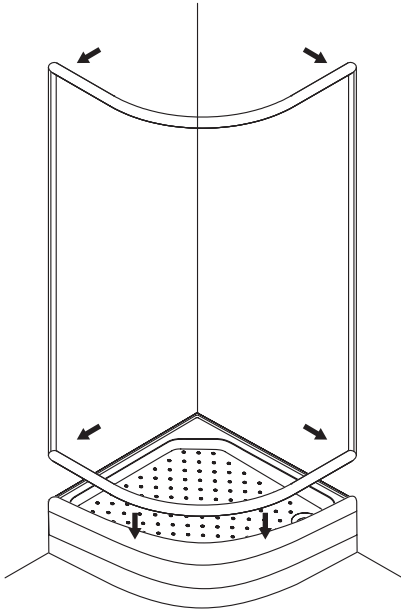

- 1
- 2
- 4
- 5
- 16

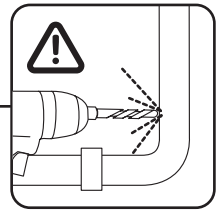
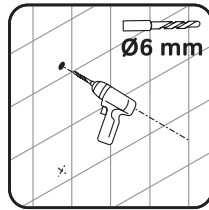
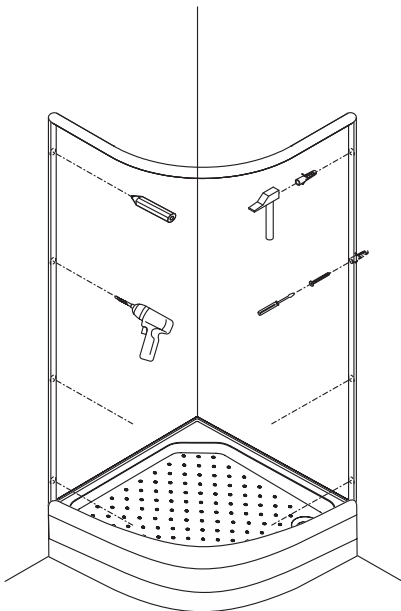

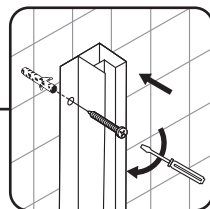
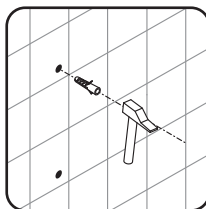
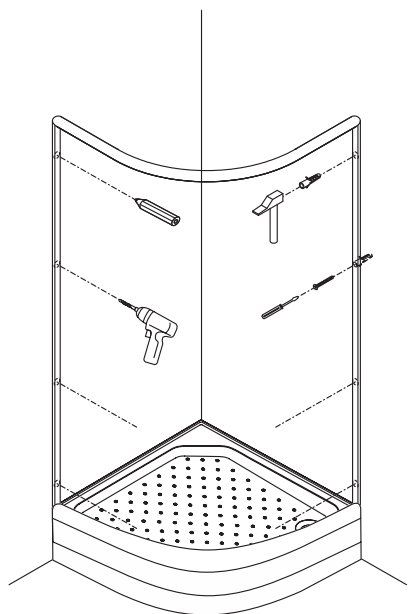

19

15

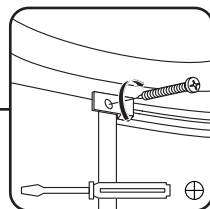
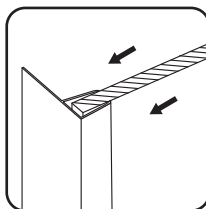
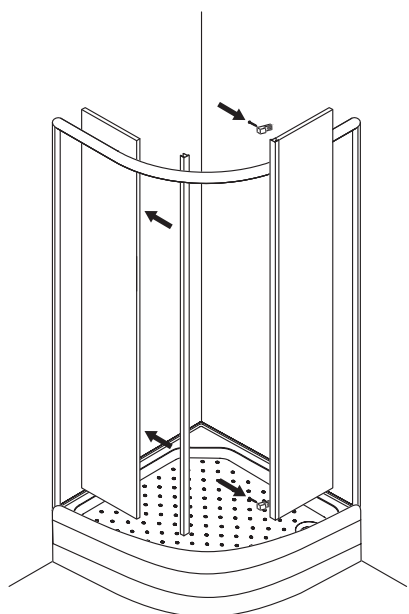

7

10

16

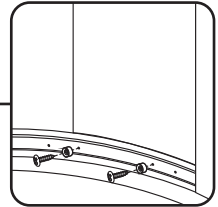
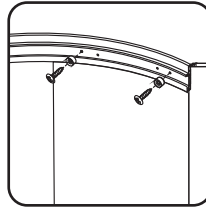
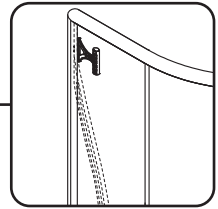
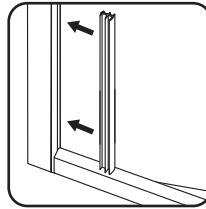
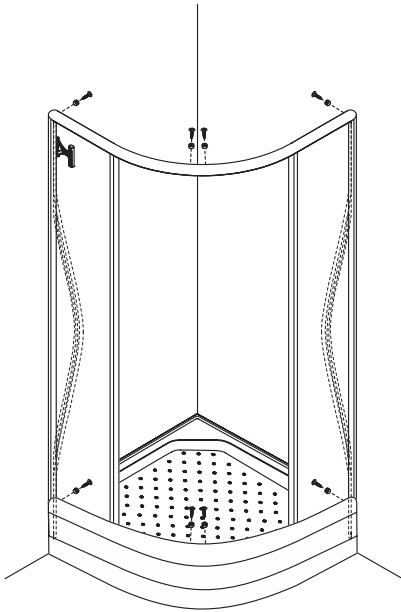

9

14

18

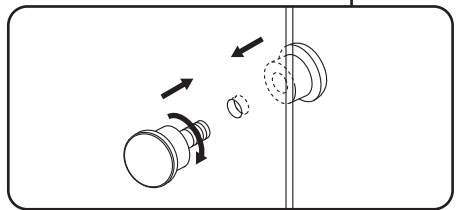
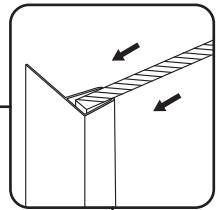
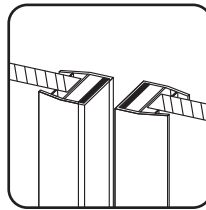
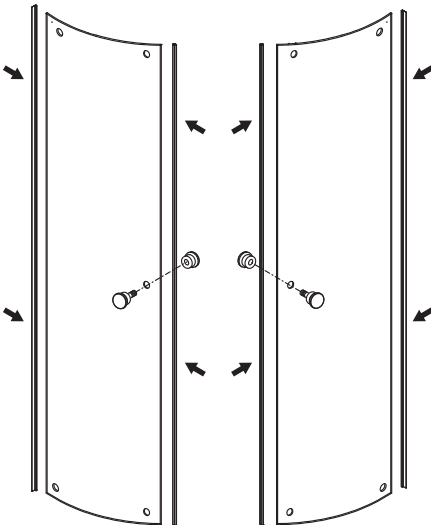

6

7

11

25

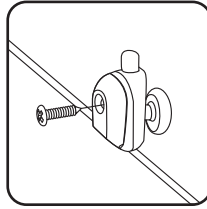
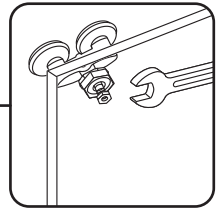
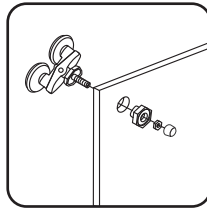
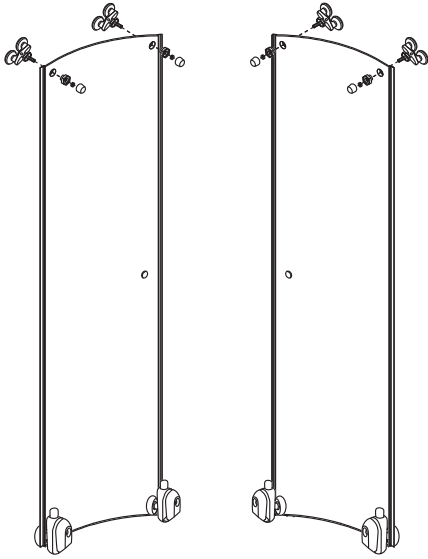

6

12

13

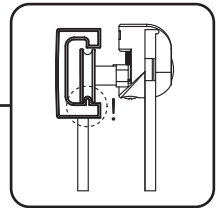
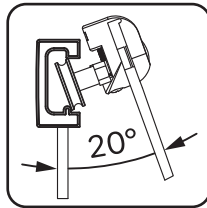
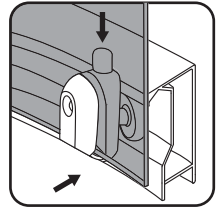
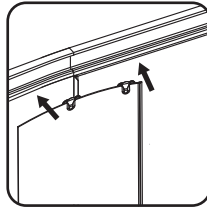
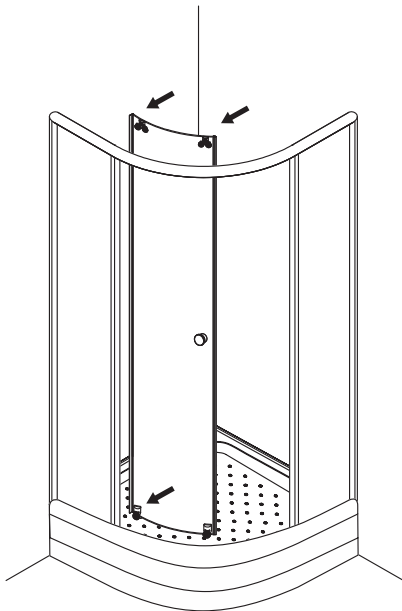

3

6

12

13

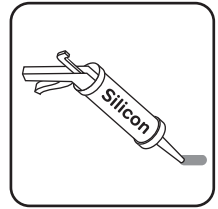
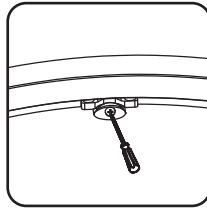
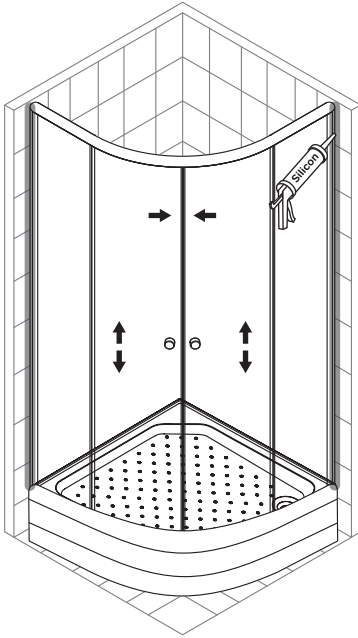

13

6

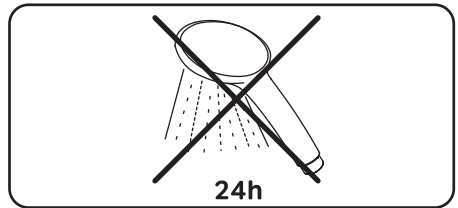
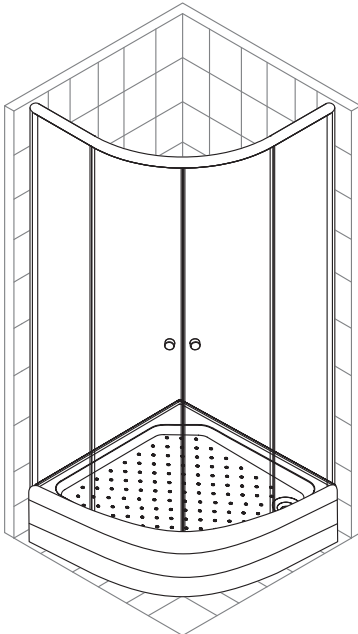

AM·PM

AM.PM Europe GmbH
Torstrasse 177 D-10115 Berlin
www.ampm-world.com 06/2018